

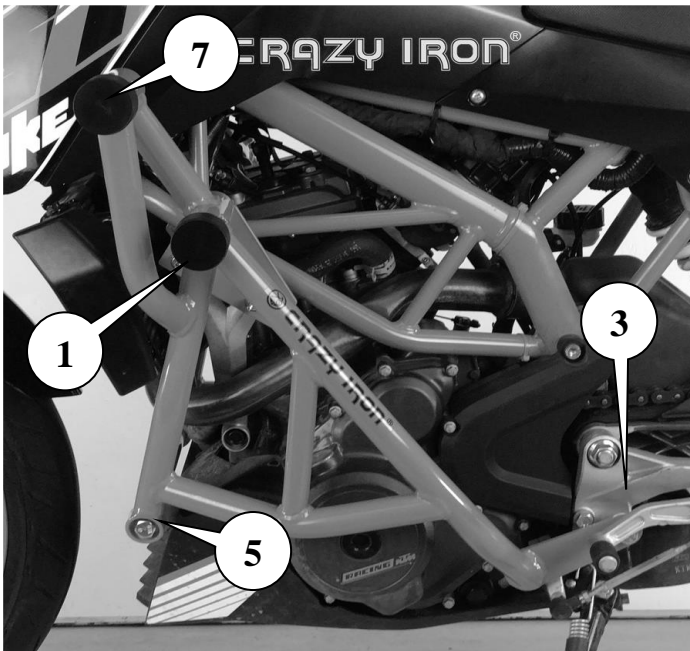

KTM Duke 125/200/390
ID: 90011/9001112/9001117

Complete set and assembly scheme:

Left side:



Right side:

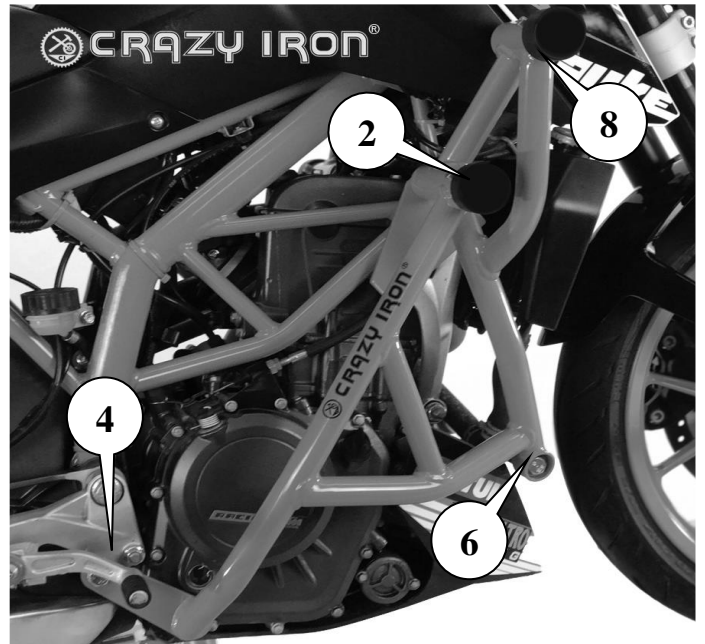

Place for mounting of plate:

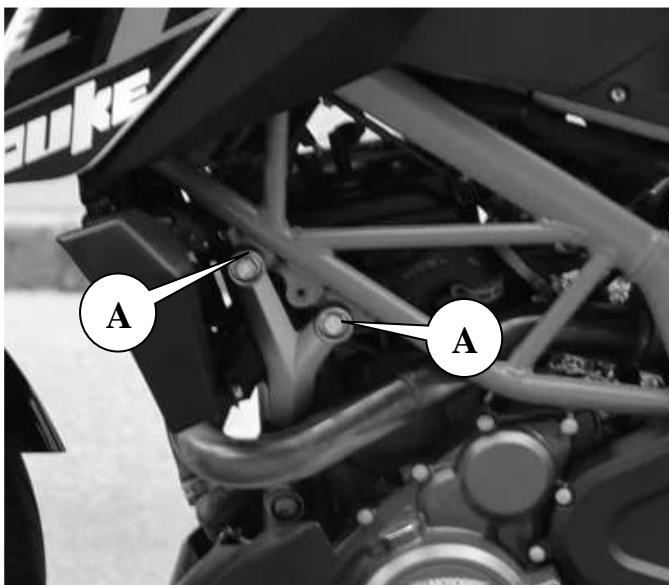

Fitting of plate

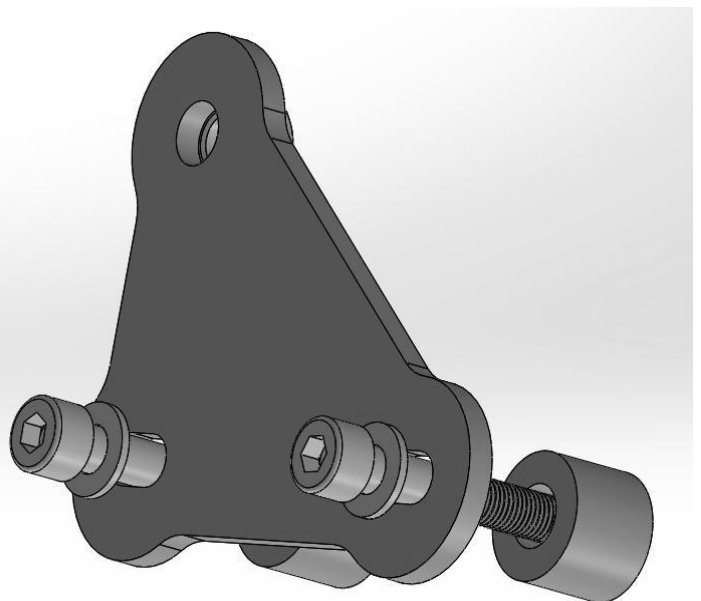

Comments:



NEVER LOOSEN ENGINE BOLTS FROM THE LEFT AND RIGHT SIDES AT THE SAME TIME!!!

In points A use bolt M8x50 for DUKE 390, M8x45 for DUKE 125/200

1. Contact a specialized service, do not install the cage yourself!
2. Remove fairing elements if they can interfere the installation of Plate
3. Remove original bolt from points A on the right side and attach Plate to points A with bolts and spacers and fix.
4. Remove original bolt from points A on the left side and attach Plate to points A with bolts and spacers and fix.
5. Remove original bolts from point 4 on the right side of motorcycle.
6. Attach right side of cage to points 4 and 2 and fix with bolt M10x120 through spacer 20x10x10 in point 4 and with bolt M10x40 in point 2
7. Remove original bolts from point 3 on the right side of motorcycle.
8. Attach left side of cage to points 3 and 1 and fix with bolt M10x120 through spacer 20x10x10 in point 3 and with bolt M10x40 in point 1
9. Install between points No5 and No6 the brace (L= 240 mm) and fix it with Bolts M10x1,25x30
10. Tighten the fasteners according to the table.
11. Install sliders in points NoNo1,2,7,8 and fix them with screws. In case Damper Cages use Damper sliders. In case crash bars install sliders only in points 1 and 2.

Tightening torques Nm		
Thread	Connection type	
	Steel	Aluminum
M6	10	6
M8	24	20
M10	48	35
M12	56	45

Component table with according numbers in the photo:

№	Items					
	Plate	Bolt M8x50 or Bolt M8x45	Spring washer	Spacer 20x10x17	Slider	Screw
1						
		Bolt M8x50 or Bolt M8x45	Spring washer	Spacer 20x10x17		
						
		Bolt M10x40				
						
2						
		Bolt M8x50 or Bolt M8x45	Spring washer	Spacer 20x10x17		
						
		Bolt M10x40				
						
3	Bolt M10x120	Spacer 20x10x10	Spring washer	Washer		
						
4	Bolt M10x120	Spacer 20x10x10	Spring washer	Washer		
						
5	Bolt M10x1,25x30	Spring washer	Washer	Brace L=240		
						
6	Bolt M10x1,25x30	Spring washer	Washer			
						
7	Slider	Screw				
						
8	Slider	Screw				
						